

INTRUDER ALARM CONTROL PANEL

complex 200H
complex 400H

BT 820/830/840/800



1 User notes



Before using the product, read the user manual carefully and keep it for future reference.



Do not open the product. All installation and maintenance work may only be carried out by an expert installer.



The user manual describes an intruder alarm control panel that is installed in accordance with VdS guidelines. Exceptions are indicated in the text.



Illustrations are intended to help the reader to understand the content in general, and can deviate from the actual design.

2 Table of content

1	User notes	2	5.4.3	Walk test.	26
2	Table of content	3	5.4.4	Disable input group.	26
3	Terms, abbreviations, and symbols	5	5.4.5	Override setting	27
3.1	Terms	5	5.4.6	Changing the keypad code	28
3.2	Abbreviations.	9	5.4.7	Reset tamper	28
3.3	Symbols	9	5.4.8	Versions	29
4	Basics of the intruder alarm system	10	5.4.9	Event memory	29
4.1	Structure	10	5.4.10	Alarm counter	30
4.2	Partitions	11	5.4.11	Disabling of keypad code	30
4.3	Setting states.	11	5.4.12	Disable comlock/cryplock code.	31
4.3.1	Externally set	11	5.4.13	comlock/cryplock identification	31
4.3.2	Internally set	12	5.4.14	Service enabling	32
4.3.3	Unset	12	5.4.15	App enabling	32
4.3.4	Alarm status and resetting	13	5.5	Operation with keypad.	33
4.4	Detector	13	5.5.1	External setting	33
5	Keypad	15	5.5.2	Internal setting.	34
5.1	Structure of touch keypad BT 800/801.	15	5.5.3	Unsetting	34
5.1.1	"Keypad" screen page.	15	5.5.4	External setting with delayed area function	35
5.1.2	"Indication panel 1/2" screen page	19	5.5.5	Unsetting with delayed area function	35
5.1.3	"Overview" screen page	20	5.5.6	Resetting alarms, faults, and battery warnings	36
5.1.4	"Switching Functions" screen page	20	6	Switching device	37
5.1.5	Settings menu	21	6.1	Structure of the reader cryplock R/K-MD	37
5.2	Structure of BT 820	22	6.2	Structure of the reader comlock R-ED	37
5.3	Access levels	22	6.3	Operation with reader	38
5.4	Menu structure	24	6.3.1	External setting	38
5.4.1	Alarm memory	25	6.3.2	Unsetting	40
5.4.2	Indication test	25	6.3.3	Change numeric-pad code with change code	42

Table of content

6.4	Operation with switching lock	43
6.4.1	Shunt lock	43
6.4.2	Pulse switching lock	43
7	System does not set. What can I do?	44
8	Maintenance and care.	46
9	Behavior in case of an alarm	47
9.1	Alarm (when externally set)	47
9.2	Alarm (when internally set).	47

3 Terms, abbreviations, and symbols

3.1 Terms

Alarm

Warning about danger to life and property.

Alarm counter

A counter built into the intruder alarm control panel that cannot be reset, which counts every intrusion, hold-up, or tamper alarm (for documentation purposes).

Indication panel

Part of some keypads. The indication panel shows the status of 16 or 32 input groups by means of LEDs. It also offers the option of disabling/enabling input groups for setting (depending on the parameterization).

Response authority

A person appointed by the responsible operator, who receives messages and initiates the necessary measures (assistance), e.g. surveillance and security service or police.

Responsible operator

The person responsible for operating the intruder alarm system and the group of people authorized by him/her to operate it.

Motion detector

A detector that detects and reports movements within its surveillance area.

Shunt lock

A switching device in the form of a lock that is integrated in the door and can be used to set and unset the system. The shunt lock also prevents setting for as long as a setting prevention criterion is present (see Coerciveness).

Intruder alarm system

The entire system with all detectors and the intruder alarm control panel.

Installer

A specialist firm that installs intruder alarm systems and carries out service and maintenance work. The employees of the installer firms are trained by the manufacturer of the intruder alarm system. The installer firms must be approved by VdS Schadenverhütung GmbH in order to install systems in compliance with VdS directives.

First alarm indication

The first input (dedicated signal or input group) triggered in the event of an alarm is specially indicated on the keypad, e.g. by blinking of the indicator. The first alarm indication indicates where the intruder entered the property.

Externally set

The responsible operator sets the system when he/she is not present in the property. The activation of an alarm results in an external alarm.

External alarm

Alerting using an externally installed warning device (siren and strobe beacon) and/or the sending of a message to the response authorities.

False alarm

An alarm for which no danger actually exists. The following causes can lead to false alarms:

- Persons or pets that are accidentally locked in
- Subsequent structural changes in the surveillance area of detectors, e.g. curtains waving and air drafts
- Insufficient maintenance of the system

Remote alerting

Alerting whereby a message is sent to the response authorities.

Walk test function

The walk test is used to check and configure the surveillance area of a motion detector. The LED on the detector is illuminated as long as a person is moving in the surveillance area and is detected by the detector.

Glass-break detectors

A detector that detects and reports the breakage of a glass pane. You can recognize the triggered detector by its LED.

Transponder

An electronic key for operating an electronic switching device. The transponder for actuation of the switching procedure is held in front of the reader belonging to the switching device. The transponder is identified by a near-field wireless connection.

Pulse switching lock

A switching device in the form of a lock that is installed beside the door and can be used to set and unset the system.

Internally set

The responsible operator sets the system when he/she is present in the property. The activation of an alarm results in an internal alarm.

Internal alarm

A signal is output by means of audible warning devices that are only installed within the property under surveillance. An internal alarm is only executed if the system is in the unset (e.g. fire detector) or internally set state.

LED

Light-emitting diodes are reliable, long-lasting and energy-saving electronic components. LEDs of different colors are used.

Magnetic contact

A contact that detects and reports the opening of, for example, doors and windows.

Input group

An input group combines multiple dedicated signals so that they can be indicated or disabled together on the keypad, e.g. motion detectors if the system is internally set.

Dedicated signal

An alarm source (detectors or inputs) that is individually detected, processed, and indicated by the intruder alarm control panel.

Input

Physical connection of multiple detectors to a common input on the intruder alarm control panel. The processing performed by the intruder alarm control panel as well as the indication on the keypad is equivalent to that of an individual dedicated signal.

Alternative power source

If there is a power supply failure of the 230 V mains supply, the function of the entire system must be guaranteed for at least 12 hours (in compliance with VdS class A). To meet this requirement, the intruder alarm control panel is fitted with a built-in rechargeable battery. The rechargeable battery is monitored by the intruder alarm control panel. In the event of a power supply fault, the intruder alarm system cannot be set (coerciveness).

Tamper contact

The intruder alarm system components' lids or parts of the housings that can be opened are equipped with tamper contacts that detect and report when the components are opened (tamper protection).

Switching device

Switching devices are used to set and unset the system. For example, it can be a shunt lock, a bolt switching lock, a switching lock or a reader.

Delayed area function

The delayed area function is used for setting or unsetting the intruder alarm system from a keypad located within the premises to be supervised. In this case, an exit time is required to allow persons to exit the property after setting the system on the keypad. At the same time, an entry time is required to allow entry into the partition for unsetting the system without activating an alarm. This function is not in compliance with VdS.

Blocking element

If an intruder alarm system is set, the blocking element blocks the door to the partition. Unintentional entry into the partition and the resulting activation of a false alarm are not possible (coerciveness).

Silent alarm

Alerting which involves sending a message to the response authorities without activating an internal/external alarm. This alarm is used for hold-ups.

Transmission device

A telecommunications device built into the intruder alarm control panel, which automatically transmits alarm, state, and fault messages via a telecommunication network to an alarm receiving center (response authority).

Unset

The system is not set. Nevertheless, some functions are still active, e.g. tamper monitoring, fault monitoring, evaluation of the technical detector, etc.

VdS (VdS Schadenverhütung GmbH)

An institution supported by the German Insurance Industry whose functions include drafting standardized guidelines and testing criteria for intruder alarm systems and carrying out approval testing of intruder alarm system concepts and specialist firms.

VdS class

Depending on the threat potential and the number of valuable items in the building, the insurance company can prescribe an intruder alarm system with a VdS class (protection class). There are three VdS classes: A, B and C (VdS class C calls for the strictest protective measures).

Lock state monitoring

The locks on all access doors to partitions are fitted with bolt contacts that monitor the lock state of the doors. It ensures the coerciveness when the system is set. The partitions can only be set if all access doors are locked. The status of lock state monitoring is displayed on the keypad.

Coerciveness

On the one hand, the coerciveness prevents the intruder alarm control panel from being set as long as a setting prevention criterion is present, e.g. if a detector is activated, a door/window opened, or if a fault state is pending. On the other hand, the coerciveness prevents the unintentional entry into the partition as long as the system is still set (see Blocking element).

3.2 Abbreviations

General

- BT = Keypad
IACP = Intruder alarm control panel
TD = Transmission device

Partition status

- Ea = External alarm
Ee = External exit time
Es = Externally set
Ev = External entry time
Ia = Internal alarm
Ie = Internal exit time
Is = Internally set
Iv = Internal entry time
Ua = Unset alarm
Us = Unset

3.3 Symbols



Important notice, order



Tips, recommendations, useful information



Usage not in compliance with VdS directives



Legend



Sequence of action



Switching device



Buzzer



LED

4 Basics of the intruder alarm system

4.1 Structure

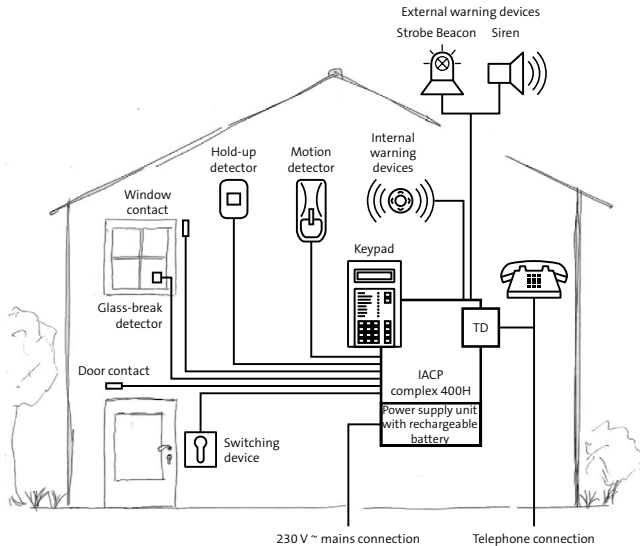

Structure of an intruder alarm system

The intruder alarm control panel (IACP) controls and monitors all functions. It supplies the entire system with electrical power. For this, the IACP features an integrated power supply unit which converts the 230 V mains supply to 12 V DC.

The TD (transmission device) transmits alarm, state, and fault messages to a response authority, e.g. surveillance and security service. The TD uses the telecommunications network for transmission.

Messages to the responsible operator on site are shown on the keypad display. With the help of the numeric pad on the keypad, the responsible operator can operate the system, e.g. look up stored information or disable input groups. Any position within the supervised property, e.g. the IACP housing, is suitable as a mounting location.

The detectors monitor the property, e.g. magnetic contacts on doors and windows, glass-break detectors, motion detectors, etc. They are combined physically into inputs and connected to the IACP inputs. Consequently, the control panel is continuously informed about the status of all detectors, e.g. whether a window is open.

If a detector detects that a window or a door is open, an alarm should only be activated if the responsible operator has set the system using the switching device.

The alerting on site is performed by the indoor warning devices when the system is internally set and by the outdoor warning devices when it is externally set.

4.2 Partitions

An intruder alarm system can include several partitions. These partitions can be set or unset either in a mutually dependent manner or completely independently of one another. In this case, each partition has its own switching device and (if necessary) a separate keypad.

Example

Strong room 1 can only be set if strong room 2 was set first.

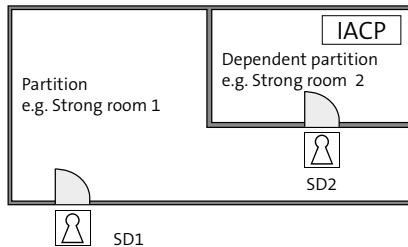

Dependent partition

4.3 Setting states

4.3.1 Externally set

 The system is set with no **persons** inside the partition(s).

The following criteria must be fulfilled for the external setting:

- No person is inside the partition
- All detectors are in the ready-to-set state
- No pending faults

Switching device is used for external setting and subsequent unsetting. There are different types of switching devices, e.g. shunt locks, bolt switching locks or readers.

In case of an alarm activation, local alerting is performed by the outdoor warning devices. In compliance with VdS, additional remote alerting via the transmission device is necessary.

4.3.2 Internally set



The system is set with **persons present** in the partition(s).

The keypad or an internal switching device is used for internal setting and subsequent unsetting. It is possible to disable specific dedicated signals (e.g. motion detectors) to enable entry into rooms in the property.

In case of alarm activation, local alerting is performed by the indoor warning devices. As an option, an external alarm and/or remote alerting can be additionally activated after a defined time and under the requirement that the alarm was not previously reset at the keypad (not in compliance with VdS directives).

4.3.3 Unset



The system is not set.

While the system is unset, some functions of the intruder alarm control panel will still be active. Important functions will never be switched off.

■ Indication

The current states are indicated on the keypad.

■ Tamper

The IACP checks the cable connections to the keypads, to the switching devices and to the external warning devices. Likewise, the housings of all components are monitored for opening. Depending on the parameterization, a tampering attempt results in an internal or external alarm.

■ Fault

The IACP monitors the voltage supply, the rechargeable battery, the transmission device, and the function of the transmission paths used. Faults that occur are indicated visually and audibly on the keypad. Transmission of faults is possible independent of the current setting state.

- **Coerciveness**
If a tamper alarm, an intruder alarm, or a fault is pending, the system cannot be set (coerciveness). Lock state monitoring also affects the coerciveness, i. e., if a detector is not in the ready-to-set state (e.g. a window is open), it is not possible to set the intruder alarm system.

4.3.4 Alarm status and resetting

After an internal or external alarm is activated, the IACP switches to the alarm state. In the alarm state, the indoor and/or outdoor warning devices in the system are activated (max. up to unsetting). Depending on the parameterization, the transmission device transmits an alarm message to the response authorities. During unsetting, the switching device signals the pending alarm. In the unset state, only the alarm LED and the buzzer on the keypad indicate the alarm state. Only after the IACP is reset does this signaling also end, which means that the system can be set again (see Keypad / Operation with keypad / Resetting alarm, faults and battery warning).

On VdS class B and C systems, the responsible operator is unable to reset a tamper alarm. The reset can only be performed by the installer of the system, who also determines the reason for activation, checks that the system is functioning correctly and seals the housing.

4.4 Detector

To ensure that the IACP can detect and report different hazardous situations, a variety of detector types must be installed in the system. Each detector type is intended for a particular hazardous situation.

The table below shows how the system reacts depending on the setting state. Depending on the parameterization, the actual reaction of the system may differ from the example shown here.

Detector	Reaction of system		
	Unset	Internally set	Externally set
Magnetic contact on doors and windows	Only displayed on keypad	Internal alarm	External alarm ⁴
Motion detector	Only displayed on keypad	Internal alarm	External alarm ⁴
Glass-break detectors	Internal alarm	Internal alarm	External alarm ⁴
Tamper contact ¹	Internal alarm	Internal alarm	External alarm ⁴
Smoke alarm device ²	Internal alarm	Internal alarm	External alarm ⁴
Technical detector (e.g. water or gas detector)	Internal alarm	Internal alarm	External alarm ⁴
Escape door monitoring ³	Internal alarm	Internal alarm	External alarm ⁴
Motion detectors in out-door areas	Only displayed on keypad	Activation of exterior lightning	
Bolt switch contact of doors and windows	No alarm, prevents setting (coerciveness)		
Hold-up alarm device	Silent alarm		

Table: Detector and reaction of the system

¹ The housings on all components are fitted with tamper contacts or similar protective mechanisms, which activate a tamper alarm in response to a mechanical attack on the components.

² When activated, the smoke alarm devices trigger a fire alarm (additional function). However, the installation of these detectors does not make the system into a fire detection and fire alarm system as defined by EN 52.

³ In the case of day monitoring of buildings that are open to the public, external doors that must not be locked for safety reasons (e.g. escape doors) are monitored. Opening these doors leads to alerting.

⁴ In compliance with VdS directives, additional remote alerting using the transmission device is necessary.

5 Keypad

A keypad is used for indicating operating states, alarms, and faults, for setting/unsetting, alarm resetting and for entry of additional control commands by the responsible operator.

TELENOT offers a variety of keypads for operating the IACP. For information, refer to the TELENOT website at www.telenot.com. The operating procedure for the IACP using the example of the touch keypad BT 800 and the LCD keypad BT 820 is explained below.

5.1 Structure of touch keypad BT 800/801

5.1.1 "Keypad" screen page

The following control and indicating elements are available on the touch keypad BT 800/801:



- ① Switching of the screen pages
- ② Icons
- ③ Freely parameterizable LEDs 1–4
- ④ Display indication
- ⑤ Numeric block
- ⑥ Operating buttons
- ⑦ LED indication (operating states)

Structure of touch keypad BT 800/801

Switching of the screen pages

- 
- ① One screen page back
 - ② "Switching Functions" screen page
 - ③ "Overview" screen page
 - ④ "Keypad" screen page
 - ⑤ "Indication Panel 1" screen page
 - ⑥ "Indication Panel 2" screen page
 - ⑦ One screen page forward

Switching of the screen pages

The page active in each case is visualized by the white square. You can select the screen page also by selecting the gray rectangle directly (2-6) or by swiping vertically on the display.

Icons



Icons

Icons	Color	Function
① Alarm	Red	Blinks for triggered and saved alarms
② Fault	Yellow	Blinks for pending and saved faults
③ Walk test	Green	Blinks if walk test activated (independent of partitions)

Table: Icon

Freely parameterizable LEDs 1–4

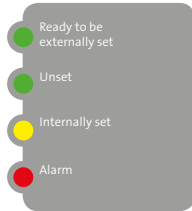

Freely parameterizable LEDs 1–4

The freely parameterizable LEDs 1–4 can indicate different states (e. g. externally set, unset, internally set, alarm etc.). The function, the text and the color of the LEDs are freely parameterizable and are defined by the installer.

Display indication

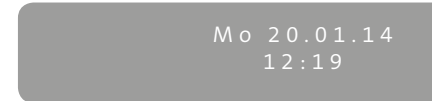

Display indication



The display has a limited number of characters. Long texts are divided in two indications, which are displayed alternatingly.







Numeric block



Numeric block

- ① Menu / digit 1
- ② Reset / digit 2
- ③ Selection / digit 3
- ④ Esc (cancel)
- ⑤ Enter (accept)

Operating buttons

-  ① Scroll back
-  ② Scroll forward
-  ③ Unsetting
-  ④ Internal setting
-  ⑤ External setting (only if enabled)
-  ⑥ Freely parameterizable button
-  ⑥

Operating buttons

LED indication (operating states)



LED indication (operating states)

LED indication (operating states)	Color	Function
① Operation	Green	Illuminated during operation and blinks during initialization
② Alarm	Red	Illuminated by triggered and saved alarms
③ Fault	Yellow	Illuminated by pending and saved faults
④ LED 4	Blue	Corresponds to the freely parameterizable LED 4 (indication even if display is switched off)

Table: LED indication

5.1.2 "Indication panel 1/2" screen page

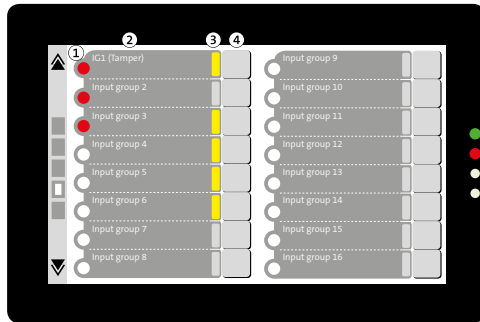

- ① LED "Input group disabled/enabled"
- ② Input group text
- ③ "Input group state" LED
- ④ "Disable/enable input group" button

"Indication panel 1/2" screen page

The screen page "Indication panel 1" of the touch keypad displays the statuses of the first 16 input groups; screen page "Indication panel 2" displays the statuses of another 16 input groups. Which input groups are displayed depends on the parameterization.

- **LED "Input group state"**: This LED (red) indicates whether at least one dedicated signal in this input group is open or in the alarm state.
- **Input group text**: The input group text is displayed here as defined in the IACP parameterization.
- **LED "Input group disabled/enabled"**: This LED (yellow) indicates whether an input group is disabled. If the input group is enabled, the LED is not illuminated.
- **Button "Disable/enable input group"**: Use this button to disable/enable the input group in question. The IACP parameterization and the access level dictate whether you can disable an input group.

5.1.3 "Overview" screen page



- ① "Keypad" overview
- ② "Indication Panel 1" overview
- ③ "Indication Panel 2" overview

"Overview" screen page

The "Overview" screen page of the touch keypad is a summary view. It displays the screen pages "Keypad", "Indication Panel 1" and "Indication Panel 2" in an overview. However, you cannot perform any operations (e.g. using operating buttons, numeric block, etc.).

5.1.4 "Switching Functions" screen page

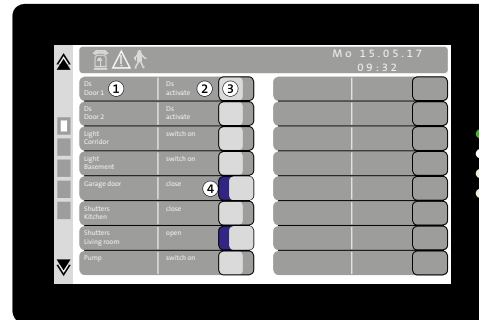

- ① Switching function text/usage
- ② Switching function operation text (ON/OFF)
- ③ Button for triggering the switching function

To activate or deactivate the switching function, hold the button down.

For as long as you hold the button down, the entire row (including the button) is colored orange. If you do not hold down the button for long enough, a notice is displayed informing you of this (e.g. button > 1 s).

- ④ The blue display (area behind the button) indicates the switching function's activated state.

"Switching Functions" screen page

5.1.5 Settings menu

From the settings menu, the following parameters can be adjusted:

- Buzzer volume during button actuation
- Brightness of the display
- Brightness of the LED display
- Color scheme of the display

- ① Hold down (approx. 5 s) the “Esc” button.

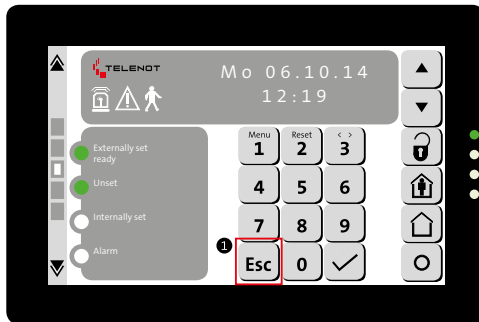

Start the settings menu

- ② Enter the access-enabling code (E3) and confirm your input with the “Enter” button. The access-enabling code (E3) that you need to use depends on the parameterization. Ask your installer.

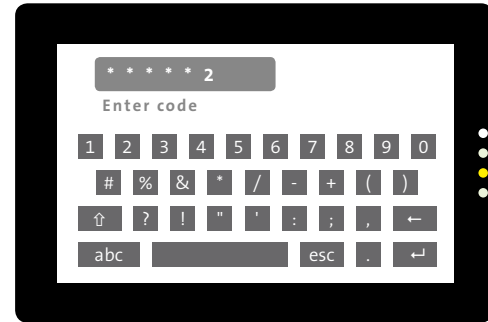

Entering the access-enabling code for the settings menu

- ③ Make the required changes.
- ④ To exit the settings menu, press the “double arrow” button.

5.2 Structure of BT 820

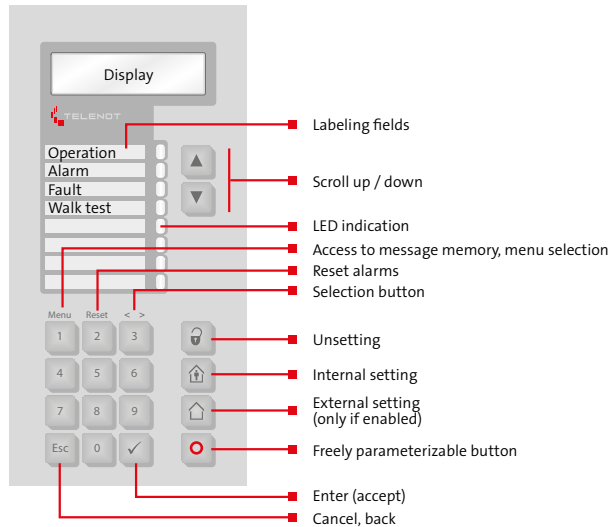

Structure of BT 820

The keypad BT 820 has a two-line display, 8 LEDs as a group and status indication, a membrane numeric pad and a built-in buzzer.



The display has a limited number of characters. Long texts are divided in two indications, which are displayed alternately.

LED indication (operating states)	Color	Function
Operation	Green	Illuminated during operation and blinks during initialization
Alarm	Red	Illuminated by triggered and saved alarms
Fault	Yellow	Illuminated by pending and saved faults
Walk test	Yellow	Illuminated if walk test is activated (independent of partitions)
4 freely parameterizable LEDs (LED 1–4)	Red, green or yellow	Can be freely parameterized (defined by the installer)

Table: LED indication

5.3 Access levels

Operation on the keypad is protected by codes (code X, Y, and Z). Every code is assigned to an access level (E1, E2, and E3). The access levels differ based on the available menu items on each level.

Menu item	Function	Access level with code			Access level without code ¹
		L1 (Code X)	L2 (Code Y)	L3 (Code Z)	VdS
Indication test?	Testing all LEDs and the buzzer on the keypad	✓	✓	✓	✓
Walk test ?	Switching the walk test for motion detectors on/off	✓	✓	✓	✓
Disable IG?	Disabling/enabling input groups		✓	✓	✓
OverrideSetting?	Switching off triggered detectors that are not in quiescent mode for one setting (not in compliance with VdS directives)		✓	✓	✓
Change KP-Code ?	Changing the keypad codes		✓	✓	✓
Reset Tamper ?	Resetting a pending tamper alarm (only if the function is enabled)		✓	✓	✓
Versions ?	Displaying the device models		✓	✓	✓
Event memory ?	Displaying of the event memory			✓	
Alarm counter ?	Total of all alarms			✓	
Disable KP-Code?	Disabling/enabling of the keypad code			✓	
Disable CL-Code?	Blocking/releasing comlock codes (e.g. HF transponders)			✓	
CL-Ident. ?	Identifying comlock codes (e.g. HF transponders)			✓	
Service release?	Unlock for remote service by the installer			✓	
App-Enable?	Unlock for the BuildSec app			✓	

Table: Access levels

¹ The installer can also configure the keypad so that a code does not need to be entered for access levels L1 and L2 (not VdS-compliant).

5.4 Menu structure

The keypad only displays the menu items that are available on the respective access level.

Due to the use of abbreviations in the representation and the large number of selection options, the display indications of the complex 400H will be used in the further graphics.

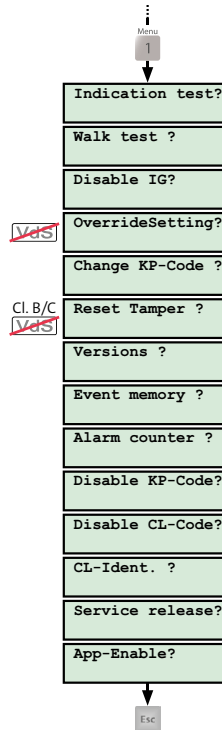
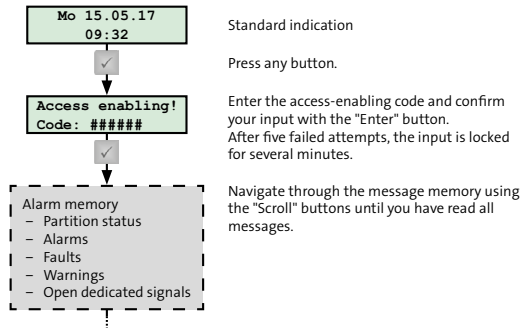

Press the "Menu" button.

Navigate through the menu using the "Scroll" buttons.

Press "Enter" to open a menu item.

To make a selection within a menu item, use the "Selection" button.

To exit a menu item, press the "Esc" button.

You can exit the menu at any time by pressing the "Esc" button or waiting until the operation period has expired.

Menu structure

5.4.1 Alarm memory

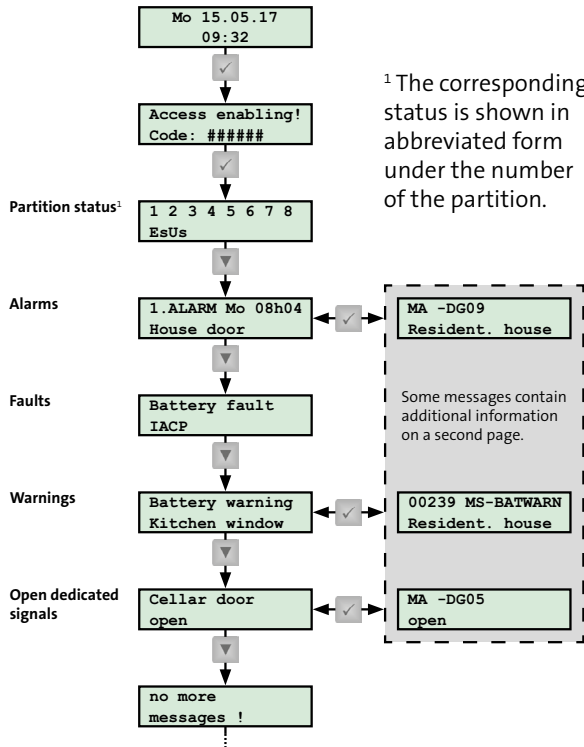

Alarm memory

The alarm memory contains the following information:

- Status of the partitions
- Pending alarms
- Pending faults
- Pending warnings
- Open dedicated signals

5.4.2 Indication test

(Access level: L1, L2 and L3)

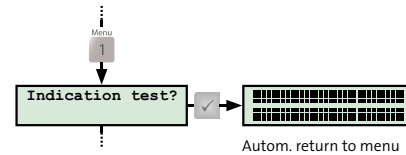

Menu item "Indication test"

During the indication test, the IACP sets off all LEDs, all positions in the display and the buzzer of the keypad (duration approx. 3 s) and then returns automatically to the menu. If you recognize a malfunction, contact the installer.

5.4.3 Walk test

(Access level: L1, L2 and L3)

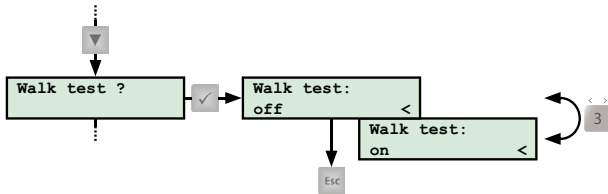

Menu item "Walk test"

The walk test is used to check and configure the surveillance area of a motion detector. The LED on the detector is illuminated as long as a person is moving in the surveillance area and is detected by the detector.

During the walk test, the yellow walk test LED is illuminated on the keypad. In one hour at the latest, the IACP automatically switches off the walk test.



For motion detectors that are connected to the IACP via a BUS-1, the walk test always switches off in one hour, regardless of whether it was previously switched off on the keypad or is still active.

5.4.4 Disable input group

(Access level: L2 and L3)

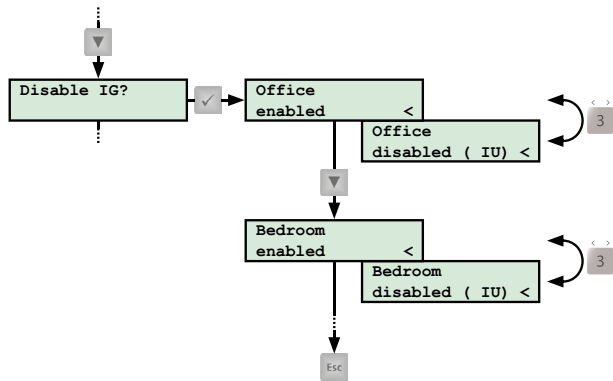

Menu item "Disable input group"

You can exclude individual input groups when setting the system. To do this, the installer must enable the input group for this process when parameterizing the intruder alarm system and must specify the type of setting (E = externally set, I = internally set and U = unset) for which the input group can be disabled.



If the keypad also includes an LED indication panel or if you are using the touch keypad BT 800/801, you can simply disable/enable the enabled input groups by pressing a button.

5.4.5 Override setting

(Access level: L2 and L3)

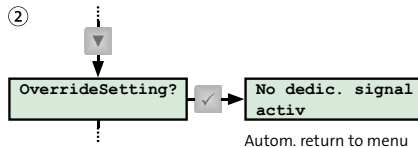
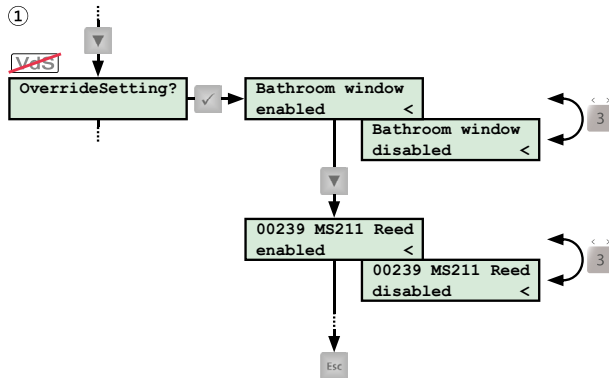

Menu item "Override setting"

The override setting makes it possible to set the intruder alarm system internally or externally despite the setting prevention (not in compliance with VdS). To do this, the installer must enable the dedicated signals for this process when parameterizing the intruder alarm system and must specify the type of setting (E = externally set, I = internally set and U = unset) for which the override setting can be executed. Only use this function in the most extreme emergency. In such a case, inform the installer immediately as a permanent setting prevention indicates a fault in the system.

If an override setting is not permitted (in compliance with VdS) or if all detectors are in quiescent mode, the menu item cannot be opened (2).



The override setting is generally not active (in compliance with VdS). It must be parametrized by the installer during commissioning.

5.4.6 Changing the keypad code

(Access level: L2 and L3)

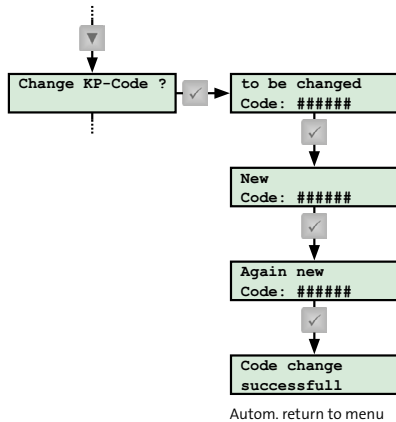

Menu item "Change keypad code"

The keypad code can be changed at any time. The number of characters is limited to 6 digits.

5.4.7 Reset tamper

(Access level: L2 and L3)

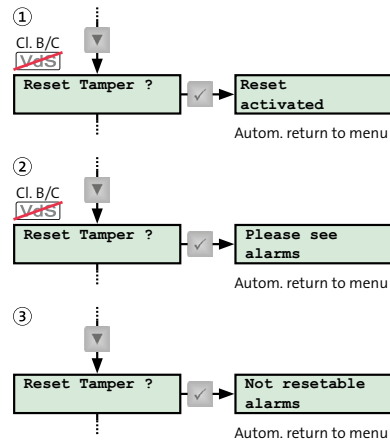

Menu item "Reset tamper"

Up to VdS class A, you can reset tamper alarms yourself (1). A reset is only possible if you have read all messages in the message memory (2). For VdS class B and C systems, a tamper alarm can only be reset by the installer who also determines the reason for the activation, checks that the system is functioning properly, and seals the housing (3).

5.4.8 Versions

(Access level: L2 and L3)

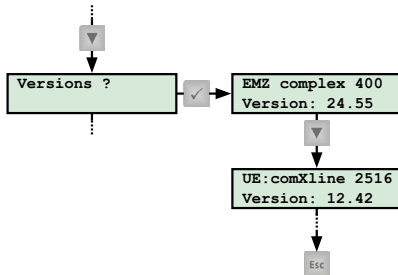

Menu item "Versions"

Under versions, the software versions of the individual components of the intruder alarm systems are listed.

5.4.9 Event memory

(Access level: L3)

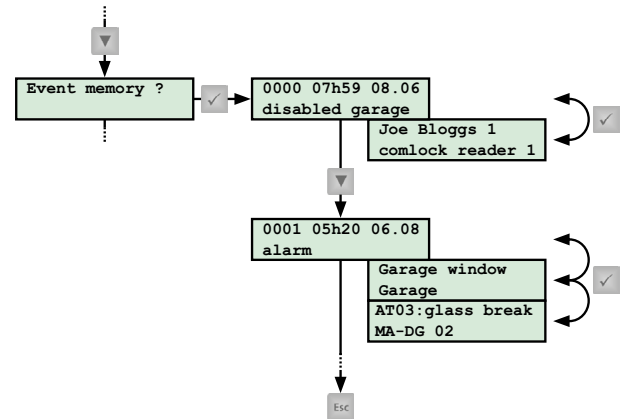

Menu item "Event memory"

All events (e.g. alarms, faults or setting/unsetting) are stored in the event memory. In addition to the date and exact time of the event, additional information is listed on a second page (e.g. which detector triggered the alarm or which person set/unset the system). The event memory can save max. 1365 events. If the maximum number is reached, the IACP overwrites the oldest events (circular buffer).

5.4.10 Alarm counter

(Access level: L3)

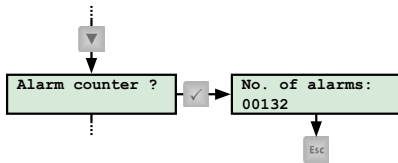

Menu item "Alarm counter"

The alarm counter counts the alarms that have occurred in the intruder alarm system. The number shown is used to document the alarms in the maintenance record book (required in VdS class C).

5.4.11 Disabling of keypad code

(Access level: L3)

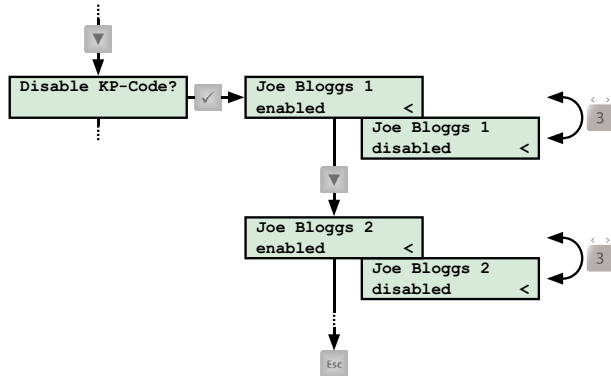

Menu item "Disable keypad code"

The keypad codes and therefore the operation of the keypad can be disabled for the individual responsible operators, e.g. if an employee has left the company.

5.4.12 Disable comlock/cryplock code

(Access level: L3)

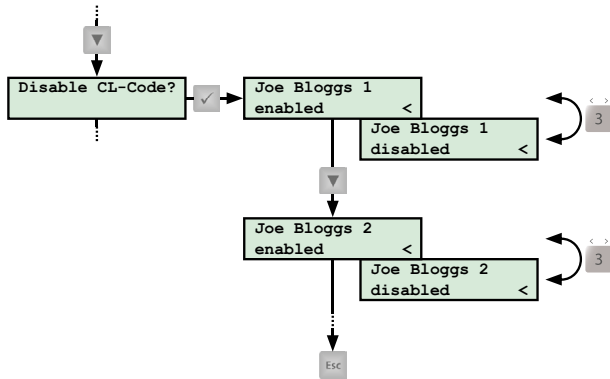

Menu item "Disable comlock/cryplock code"

The comlock/cryplock codes and therefore the operation of the switching device can be disabled for the individual responsible operators, e.g. if a transponder has been lost.

5.4.13 comlock/cryplock identification

(Access level: L3)

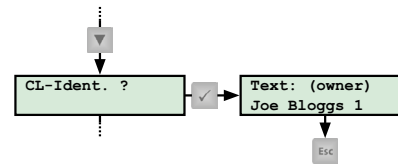

Menu item "comlock/cryplock identification"

During comlock/cryplock identification, you can identify a (e.g. found) transponder. To do this, open the menu item and hold the transponder in front of a reader of the intruder alarm system. The parameterized owner is displayed.

5.4.14 Service enabling

(Access level: L3)

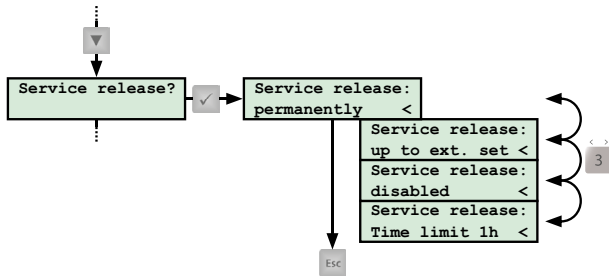

Menu item "Service enabling"

With the service enabling, you allow the installer to access and maintain your IACP. Maintenance can be performed remotely or on site.

5.4.15 App enabling

(Access level: L3)

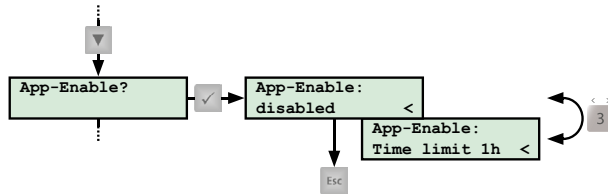

Menu item "app enabling"

With app enabling, you allow the installer to access your IACP and operate it via the app. The installer also uses this function to demonstrate the app to you.

The app enabling has no effect on your app.

5.5 Operation with keypad

Due to the use of abbreviations in the representation and the large number of selection options, the display indications of the complex 400H will be used in the further graphics.

You can externally set, internally set, or unset the partitions permitted for the respective keypad and the respective access level.

5.5.1 External setting

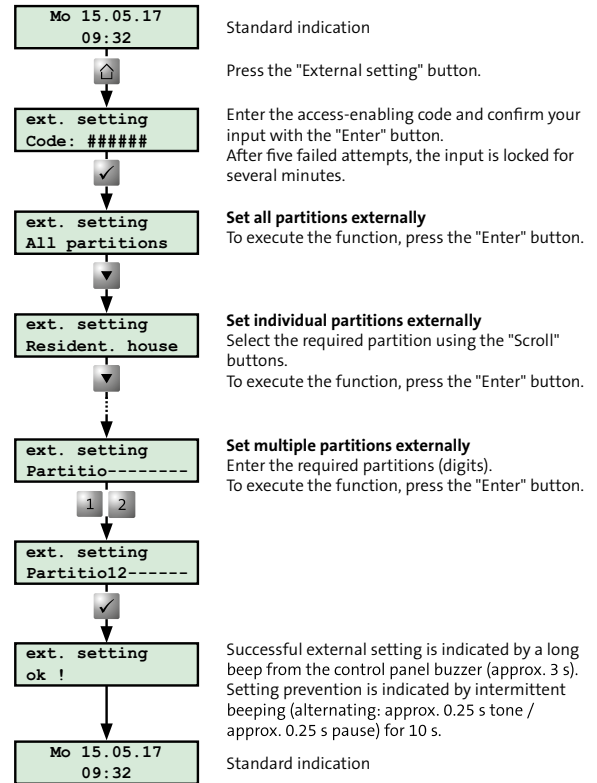

External setting

5.5.2 Internal setting

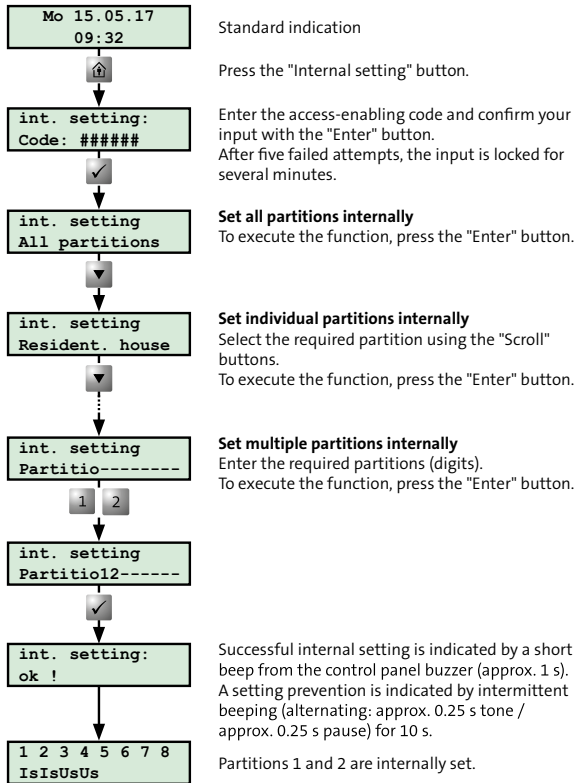

Internal setting

5.5.3 Unsetting

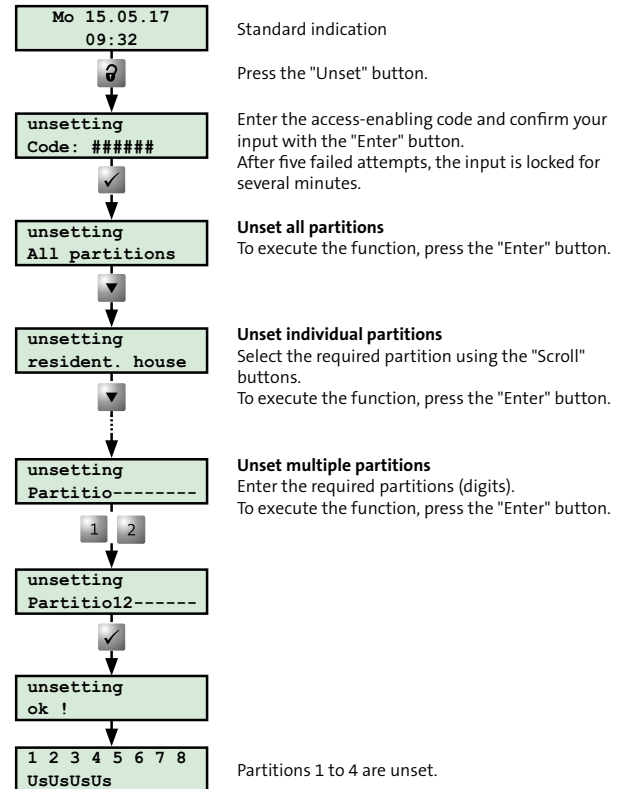

Unsetting

5.5.4 External setting with delayed area function



During the exit time, only the detectors associated with the delayed area are delayed. All other detectors trigger an alarm immediately.

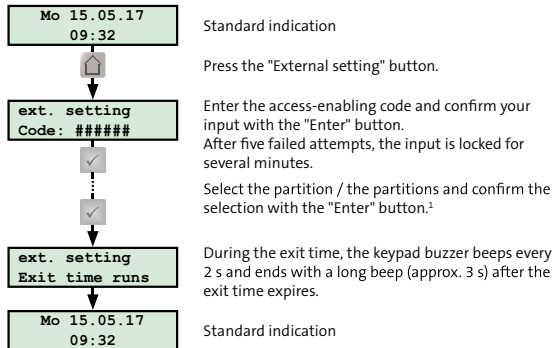

External setting with delayed area function

¹ The selection of the partition(s) is the same as the process used for external setting, see Keypad / Operation with keypad / External setting.

5.5.5 Unsetting with delayed area function



During the entry time, only the detectors associated with the delayed area are delayed. All other detectors trigger an alarm immediately.

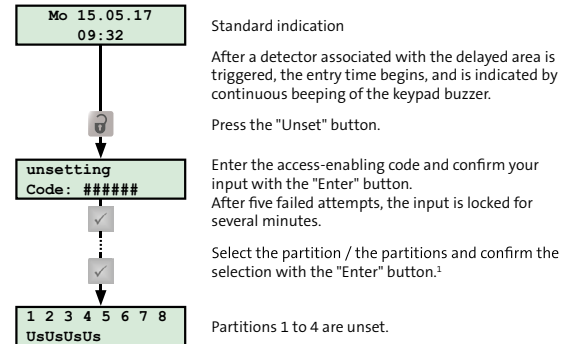

Unsetting with delayed area function

¹ The selection of the partition(s) is the same as the process used for unsetting, see Keypad / Operation with keypad / Unsetting.

5.5.6 Resetting alarms, faults, and battery warnings



You can only reset alarms, faults, and warnings that are permitted for the respective keypad and respective authorization level. Tamper alarms up to VdS class A must be reset in a separate menu ("Reset tamper"). Tamper alarms of VdS classes B and C can only be reset by the installer.



If the battery warning occurs, have the relevant batteries replaced by the installer within the next two weeks. If this is not done, a battery fault occurs. The battery fault can only be reset after the batteries have been replaced. In the intervening period, external setting of the system is no longer possible.

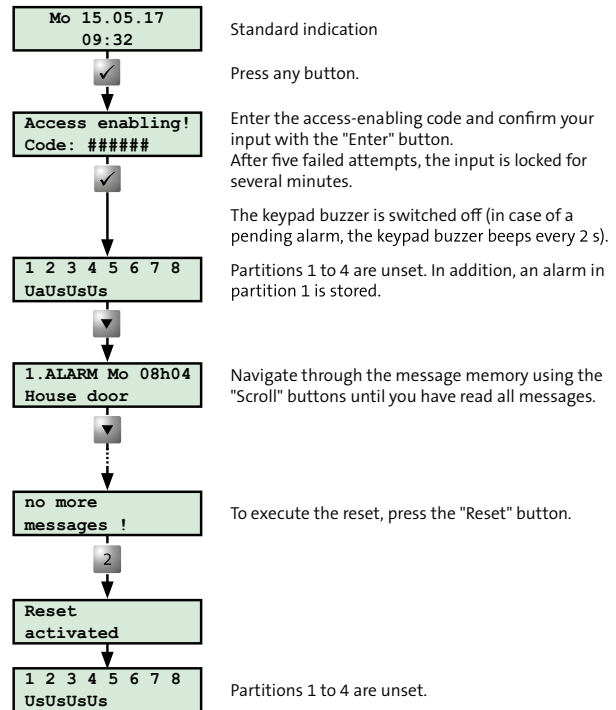

Resetting alarms, faults, and battery warnings

6 Switching device

A responsible operator can use a reader to set/unset the system. The reader is operated with a transponder, entry of a numeric-pad code or a combination of both variants.

6.1 Structure of the reader cryplock R/K-MD

The reader cryplock R/K-MD is fitted with a numeric pad, a transponder zone, three LEDs and a built-in buzzer.

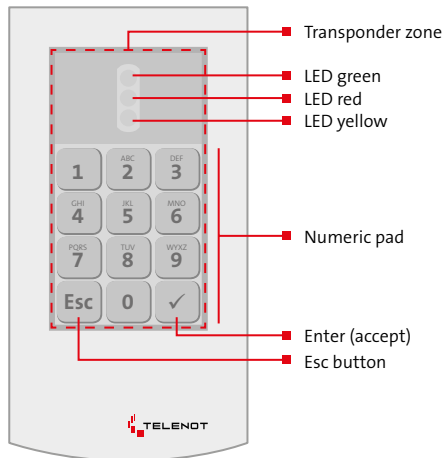

Structure of the reader cryplock R/K-MD

6.2 Structure of the reader comlock R-ED

The reader cryplock R-ED is fitted with a numeric pad, a transponder zone, a three-color LED, and a built-in buzzer.

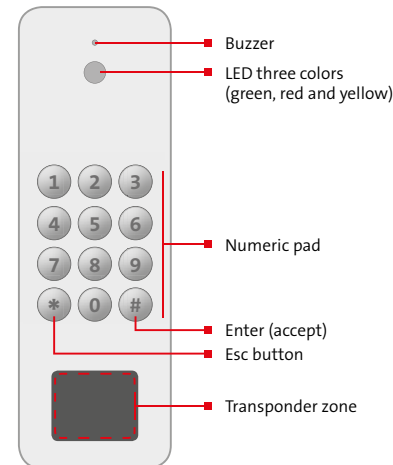

Structure of the reader comlock R-ED

6.3 Operation with reader

6.3.1 External setting

External setting with transponder

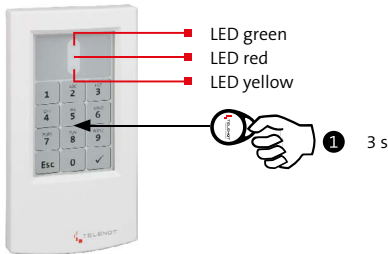

Externally set

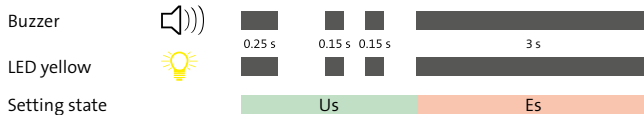

Setting prevention

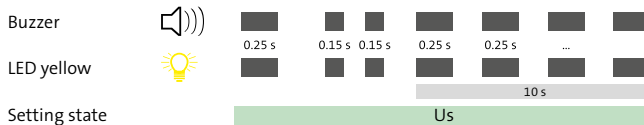

External setting with transponder

- ① Hold the transponder (approx. 3 s) in front of the reader (transponder zone). The maximum clearance is 10 mm. Confirmation: Single beep from the buzzer (approx. 0.25 s) and brief illumination of the yellow LED (approx. 0.25 s). This is followed by: Double beep from the buzzer (2 × approx. 0.15 s) and double illumination of the yellow LED (2 × approx. 0.15 s).

② Externally set

The intruder alarm system is externally set. Confirmation: Long high tone from the buzzer (approx. 3 s) and long illumination of the yellow LED (approx. 3 s).

or

Setting prevention

The intruder alarm system is **not** externally set. Confirmation: Intermittent beep of the buzzer for 10 s (alternating: approx. 0.25 s tone / approx. 0.25 s pause) and intermittent illumination of the yellow LED (alternating: approx. 0.25 s on / approx. 0.25 s off).

External setting with numeric-pad code

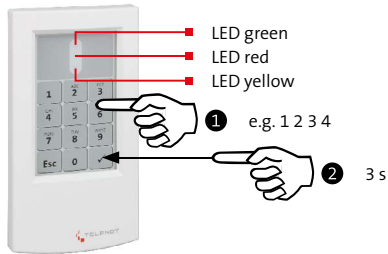

Externally set

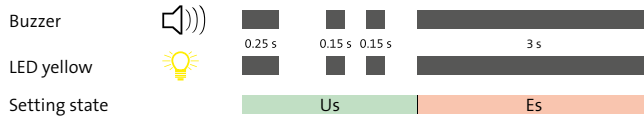

Setting prevention

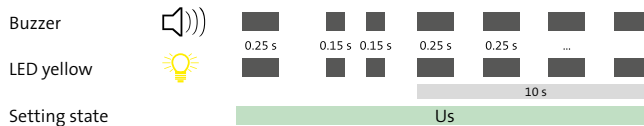

External setting with numeric-pad code

- 1 Enter the numeric-pad code. Every numerical input is confirmed with a beep from the buzzer (approx. 0.15 s) and brief illumination of the yellow LED (approx. 0.15 s). **If you make an incorrect entry, press the “Esc” button and enter the numeric-pad code again.**
- 2 Complete the code input by pressing the Enter button long (approx. 3 s).
Confirmation: Single tone from the buzzer (approx. 0.25 s) and brief illumination of the yellow LED (approx. 0.25 s).
This is followed by: Double tone from the buzzer (2 x approx. 0.15 s) and double illumination of the yellow LED (2 x approx. 0.15 s).
- 3 **Externally set**
The intruder alarm system is externally set.
Confirmation: Long high tone from the buzzer (approx. 3 s) and long illumination of the yellow LED (approx. 3 s).

or

Setting prevention

The intruder alarm system is **not** externally set.
Confirmation: Intermittent beep of the buzzer for 10 s (alternating: approx. 0.25 s tone / approx. 0.25 s pause) and intermittent illumination of the yellow LED (alternating: approx. 0.25 s on / approx. 0.25 s off).

6.3.2 Unsetting

Unsetting with transponder

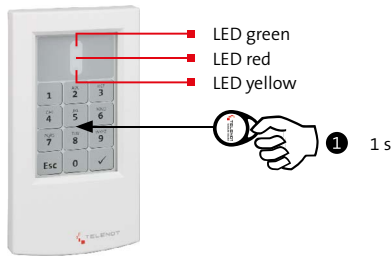

Unset (without alarm)

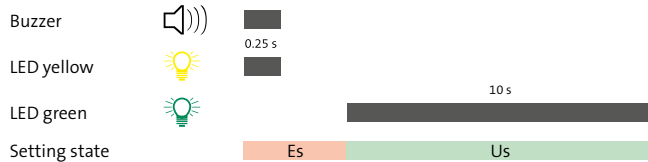

Unset (with pending alarm)

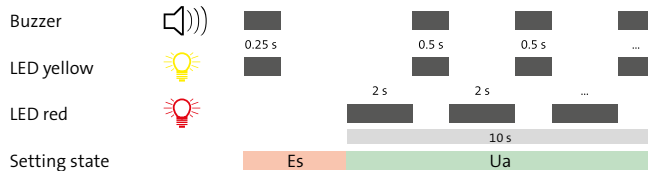

- 1 Hold the transponder briefly (approx. 1 s) in front of the reader (transponder zone). The maximum clearance is 10 mm.

Confirmation: Single beep from the buzzer (approx. 0.25 s) and brief illumination of the yellow LED (approx. 0.25 s).

- 2 **Unset (without alarm)**

The intruder alarm system is unset.
Confirmation: long illumination of the green LED (approx. 10 s).

or

Unset (with pending alarm)

The intruder alarm system is unset.
Confirmation: Alternating illumination of the yellow LED and beep of the buzzer for 10 s (approx. 0.5 s tone and yellow LED / approx. 2 s pause). During the pause, the red LED is illuminated without a buzzer signal. The keypad buzzer is also actuated.

Unsetting with transponder

Unsetting with numeric-pad code

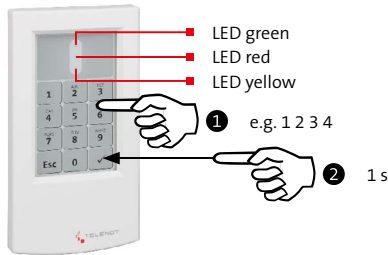

Unset (without alarm)

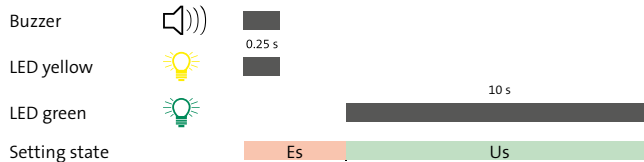

Unset (with pending alarm)

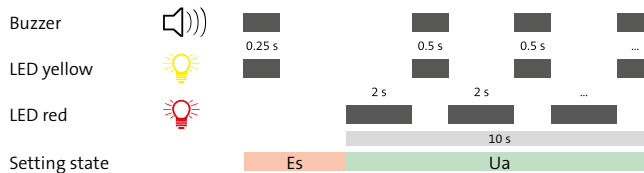

Unsetting with numeric-pad code

- 1 Enter the numeric-pad code. Every numerical input is confirmed with a beep from the buzzer (approx. 0.15 s) and brief illumination of the yellow LED (approx. 0.15 s). **If you make an incorrect entry, press the “Esc” button and enter the numeric-pad code again.**
- 2 Complete the code input by briefly pressing (approx. 1 s) the “Enter” button.
Confirmation: Single beep from the buzzer (approx. 0.25 s) and brief illumination of the yellow LED (approx. 0.25 s).
- 3 **Unset (without alarm)**
The intruder alarm system is unset.
Confirmation: long illumination of the green LED (approx. 10 s).

or

Unset (with pending alarm)

The intruder alarm system is unset.
Confirmation: Alternating illumination of the yellow LED and beep of the buzzer for 10 s (approx. 0.5 s tone and yellow LED / approx. 2 s pause). During the pause, the red LED is illuminated without a buzzer signal. The keypad buzzer is also actuated.

6.3.3 Change numeric-pad code with change code

On a numeric-pad reader, you can use the change code to change the parameterized numeric-pad code.



A change attempt has a time limit of 30 s. If the time limit is exceeded, the system switches from change mode back to normal operation.

- ① Enter the change code.
- ② Complete the code input by briefly pressing (approx. 1 s) the “Enter” button.
Confirmation: Continuous beep from the buzzer and continuous illumination of the yellow LED.
- ③ Enter the numeric-pad code to be changed.
- ④ Complete the code input by briefly pressing (approx. 1 s) the “Enter” button.
Confirmation: Intermittent double beep of the buzzer (alternating: approx. 2 x 0.25 s tone / approx. 0.5 s pause) accompanied by simultaneous illumination of the yellow LED (alternating: approx. 2 x 0.25 s illuminated / approx. 0.5 s off).
- ⑤ Enter the new numeric-pad code.
- ⑥ Complete the code input by briefly pressing (approx. 1 s) the “Enter” button.
Confirmation: Continuous beep from the buzzer and continuous illumination of the yellow LED.

⑦

Enter the new numeric-pad code again.

Notice: You have 5 s to enter the code, otherwise the process is canceled.

⑧

Complete the code input by briefly pressing (approx. 1 s) the “Enter” button.

Confirmation: buzzer goes off. The green LED is continuously illuminated for approx. 10 s if the new numeric-pad code was adopted.



It is **not** possible to use a change code to change the numeric code on a reader that is connected to the door module comlock 410 when it is in “Day alarm” operating mode.

6.4 Operation with switching lock

6.4.1 Shunt lock

External setting

- ① Lock the door lock.
- ② Lock the shunt lock.
- ③ **Externally set**
The intruder alarm system is externally set.
Confirmation: Long high tone of the buzzer (approx. 3 s).
or
Setting prevention
The shunt lock cannot be locked.

Unsetting

- ① Unlock the shunt lock.
- ② **Unset (without alarm)**
The intruder alarm system is unset.
or
Unset (with pending alarm)
The intruder alarm system is unset.
Confirmation: Intermittent beep of the buzzer for 10 s (alternating: approx. 0.5 s tone / approx. 2 s pause). The keypad buzzer is also actuated.
- ③ Unlock the door lock.

6.4.2 Pulse switching lock

External setting

- ① Insert the key into the lock and turn it to the right.
- ② **Externally set**
The intruder alarm system is externally set.
Confirmation: Long high tone of the buzzer (approx. 3 s).
or
Setting prevention
The intruder alarm system is **not** externally set.
Confirmation: Intermittent high tone of the buzzer for 10 seconds (approx. 0.25 s tone / ca. 0.25 s pause).

Unsetting

- ① Insert the key into the lock and turn it to the left.
- ② **Unset (without alarm)**
The intruder alarm system is unset.
or
Unset (with pending alarm)
The intruder alarm system is unset.
Confirmation: Intermittent beep of the buzzer for 10 s (alternating: approx. 0.5 s tone / approx. 2 s pause). The keypad buzzer is also actuated.

7 System does not set. What can I do?



The setting prevention is indicated by intermittent beeping of the buzzer (alternating: approx. 0.25 s tone / approx. 0.25 s pause) for 10 s.



For external setting: The "Operation" LED and the "Ready for external setting" LED must be illuminated green.

For internal setting: The "Operation" LED and the "Ready for internal setting" LED must be illuminated green.

On delivery from the factory, the LEDs "Ready for external setting" and "Ready for internal setting" are at the positions shown. Depending on the parameterization, however, these can differ.

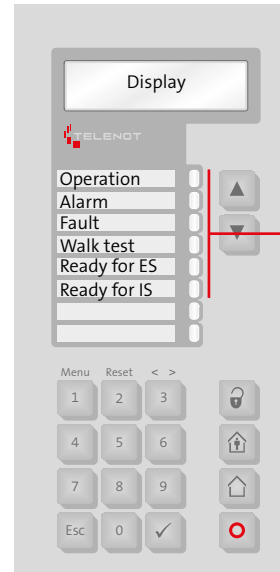

LED "Operation"

LED "Alarm"

LED "Fault"

LED "Walk Test"

LED "Ready for External Setting"

LED "Ready for Internal Setting"

Keypad LED indication

LED indication (operating states)	Cause	What to do?
LED "Operation" is not illuminated	The system is already externally set	
LED "Alarm" is illuminated	An alarm is not yet reset	Read the message memory to determine the alarm in question. If there is no longer any danger, reset the alarm (see Keypad / Operation with keypad / Resetting alarms, faults and battery warnings). You can also reset tamper alarms up to VdS class A (see Keypad / Menu structure / Reset tamper). In case of tamper alarms of VdS classes B and C, inform the installer.
LED "Fault" is illuminated	A fault is pending	Read the alarm memory to determine the fault in question. If you are unable to rectify the fault yourself, inform the installer.
LED "Ready for external setting" is not illuminated	A detector is continuously triggered or a partition door is not locked (Exception: door to switching device)	Read the alarm memory to determine which detector was triggered (e.g. open window). Set the detector to ready-to-set (e.g. close the window).
LED "Ready for external setting" is illuminated, but external setting with the switching device is not possible	Door to switching device is not locked	Lock the door lock.
LED "Ready for internal setting" is not illuminated	A detector is continuously triggered or a partition door is not locked	Read the alarm memory to determine which detector was triggered (e.g. open window). Set the detector to ready-to-set (e.g. close the window).

Table: System does not set. What can I do?



If the keypad is also fitted with an LED indication panel, or if you are using the touch keypad BT 800/801, it can display an activated detector, alarm point, input group, or lock state monitoring by means of the LEDs.

8 Maintenance and care

- Since the IACP is operated in clean indoor rooms, there is generally no need for cleaning. However, should cleaning be necessary, wipe the housing with a damp, but not wet, soft cloth. Do not use aggressive cleaning agents for this purpose (do not use thinners). This also applies to the other components of the intruder alarm system.
- The touch keypad 800/801 can be cleaned using common household glass cleaning agents such as Sidolin or special cleaning cloths for computer screens.



Touch the screen with at least two fingers to place the touch keypad BT 800/801 into "cleaning mode" before you clean the screen. Entries are not registered for as long as you are touching the screen with at least two fingers.

- When cleaning infrared motion detectors, take care not to damage the protective foil in front of the infrared entrance port as otherwise the sensitivity of the detector will be impaired.
- Check the function of the motion detectors at regular intervals. To do this, switch on the walk test with the system unset (see Keypad / Menu structure / Walk test). Walk through the detector's surveillance area. The LED on the detector is illuminated for as long as a person is detected.

- In compliance with VdS class C, three inspections (VdS class B: two inspections) and one maintenance of the system and system part must be carried out annually by the installer and documented in the maintenance record book.

9 Behavior in case of an alarm

9.1 Alarm (when externally set)

Non self-triggered alarm

- ① Remain calm.
- ② For intruder alarm systems with an external alarm without remote alerting: Call for assistance.
- ③ Never enter the property alone. Wait for the arrival of the response authority.

Self-triggered alarm

- ① Unset the intruder alarm system.
- ② Reset the alarm on the keypad.
- ③ Inform the response authority as soon as possible and give the all-clear.

9.2 Alarm (when internally set)

Non self-triggered alarm

- ① Remain calm.
- ② For intruder alarm systems with an internal alarm without remote alerting: Assess the situation and call for assistance. Avoid confronting the intruder.
- ③ Do not intervene yourself under any circumstances. Wait for the arrival of the response authority.

Self-triggered alarm

- ① Unset the intruder alarm system.
- ② Reset the alarm on the keypad.
- ③ Inform the response authority as soon as possible and give the all-clear.

Subject to technical modifications

110061512 (09)